

PUSH LATCH SWITCH

P/N:PT-02



SPECIFICATIONS

Environmental

Operating Temperature: -25~+70°C
 Relative Humidity: (40°C) ≤95%

Packaging

Bulk Package
 Inner Package: Plastic bag
 Outer Package: Carton

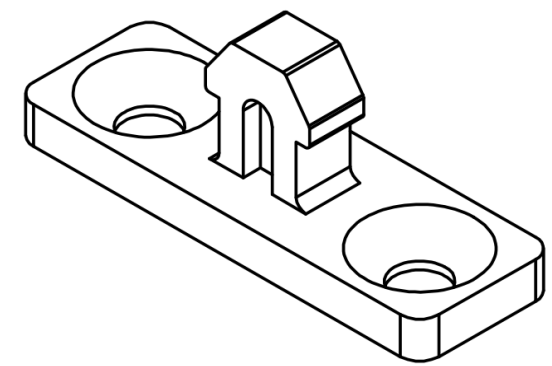
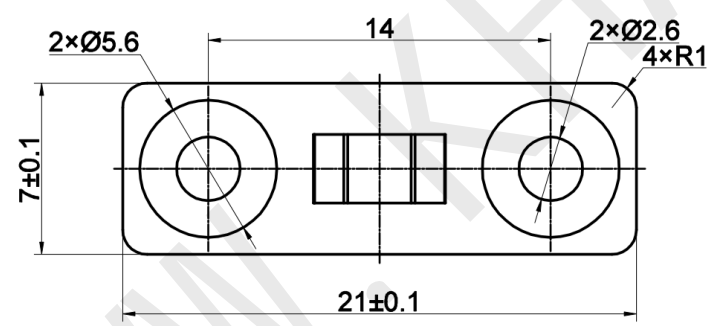
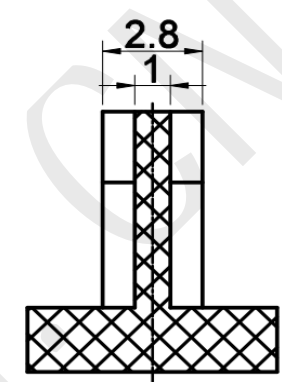
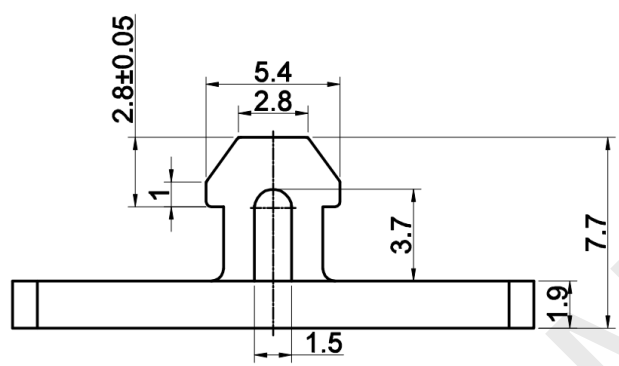

VERSION		PROJECTION	DESIGN	YUDA AO
KH14FE22E			DRAWN	ZHIJIE LU
SCALE	SIZE	 Dimensions are shown:mm(inches)	APPROVAL	JUNHUI XU
4:1	A4		2015.12.05	